

SCHUTZBLECHSET FÜR LS-PRO 16 - 26 | MUDGUARDSET FOR LS-PRO 16 - 26

MONTAGEANLEITUNG | ASSEMBLY INSTRUCTIONS

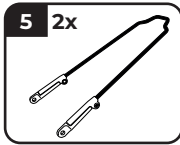

ACHTUNG: VERSCHRAUBUNG REGELMÄSSIG AUF FESTIGKEIT PRÜFEN
ATTENTION: CHECK SCREW CONNECTION REGULARLY FOR STRENGTH

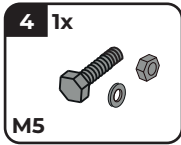
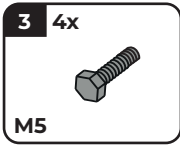
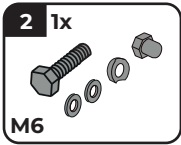
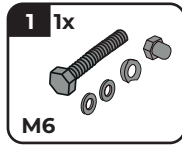
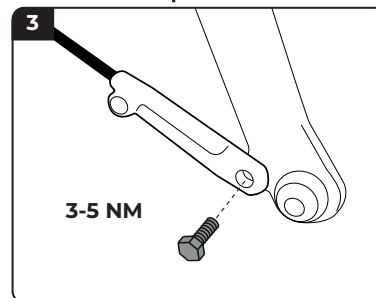
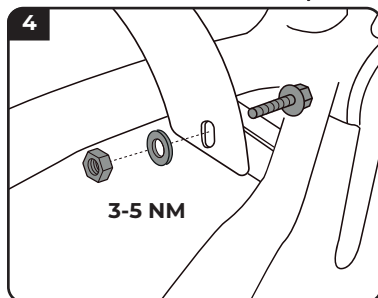
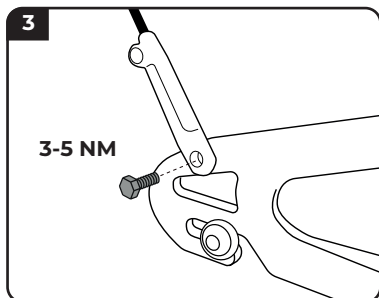
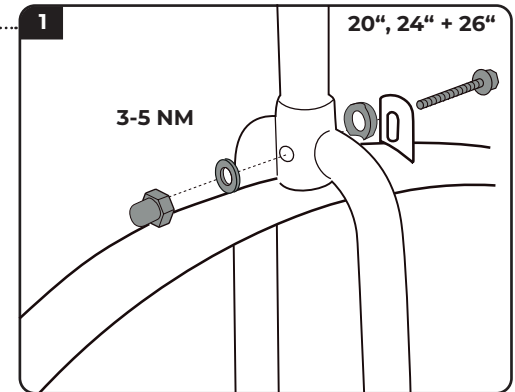
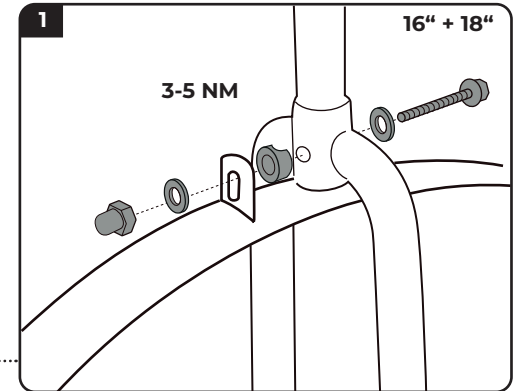
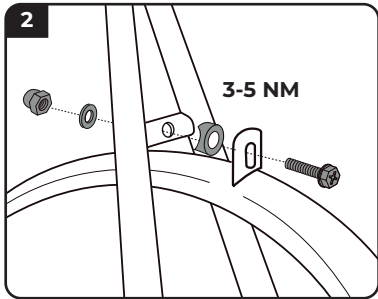
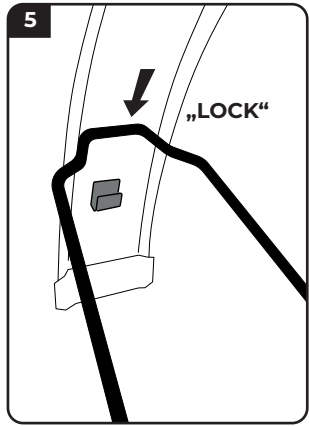

Für die Montage benötigen Sie folgendes Werkzeug.
 The following tools are required for installation.

